

Monaco 3000. Armarios puerta corredera.

V.i.P.
by Wiemann



Tested for Harmful
emission
Emission Tested
probado



made in
germany

Sistema de armarios Monaco.

V.i.P.
by Wiemann



MONACO 3000 - armarios completos

propuestas armarios

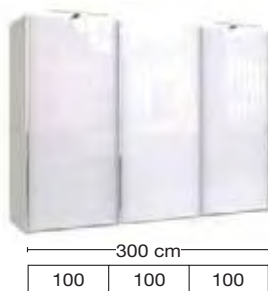

Puertas centrales con
apertura sincronizada

Para estos **armarios completos** se pueden usar **opcionalmente marcos passepartout o cornisas** también opcionalmente con iluminación integrada (ver accesorios).

Armarios combinados (se pueden combinar individualmente) de los programas MONACO 1000 + 2000 + 3000

1. Ejemplo:

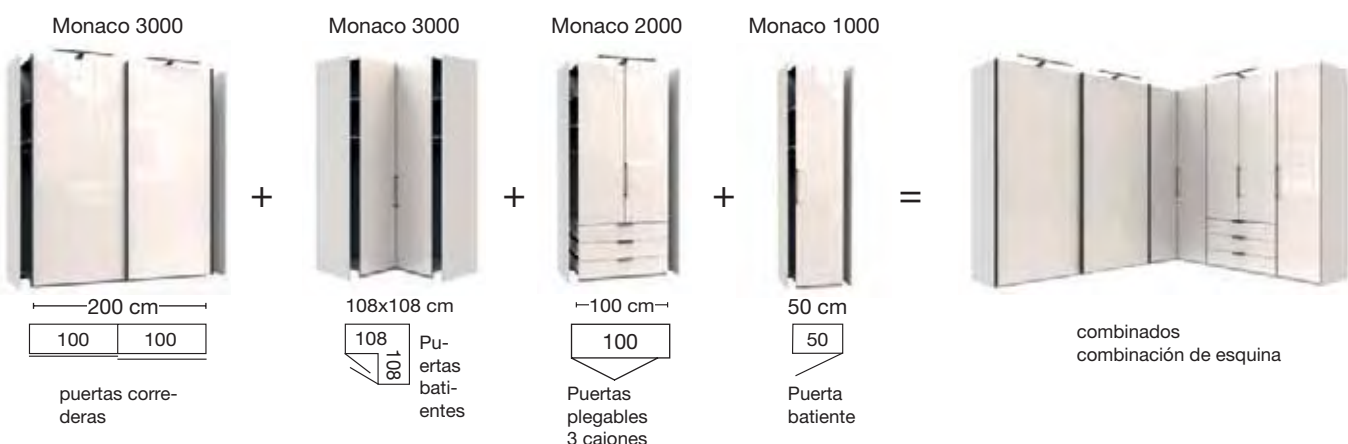

2. Ejemplo:

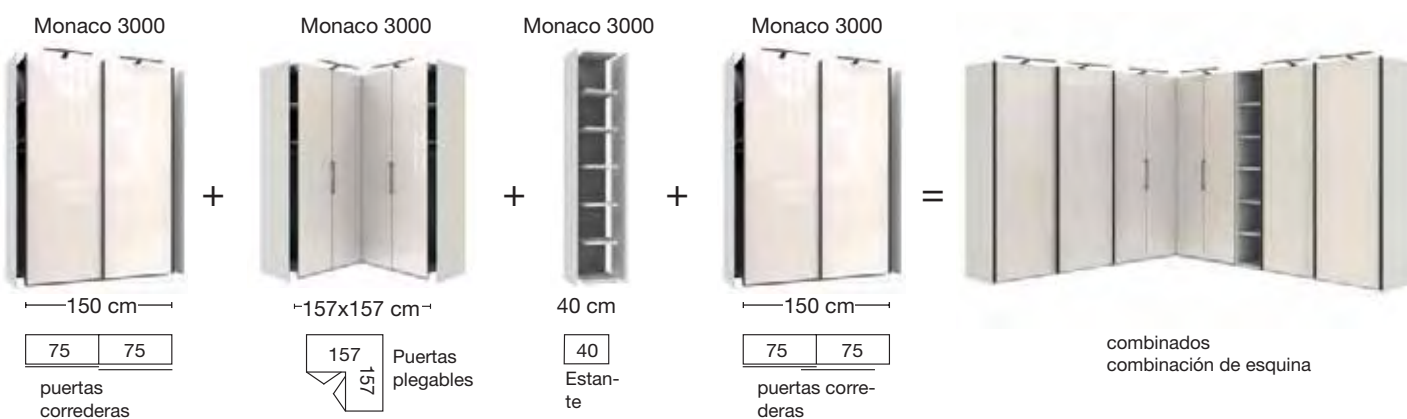

Los armarios individuales tienen dos costados exteriores para cada armazón y se colocan uno al lado del otro.

Para estos armarios de planificación se necesitan opcionalmente iluminación exterior.

Monaco 3000.

V.i.P.
by Wiemann

COLORES DE ARMAZÓN Y FRENTES DISPONIBLES

Por favor, con cada pedido indique la combinación de colores de frente y armazón exacta!

Colores disponibles:

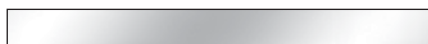

Tiradores corridos cromados



Tiradores corridos plateados



Perfiles tirador en pizarra NB

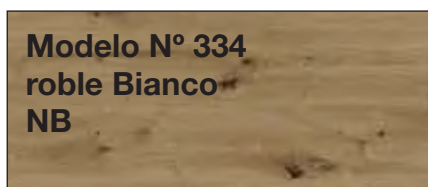

**Modelo N° 334
roble Bianco
NB**

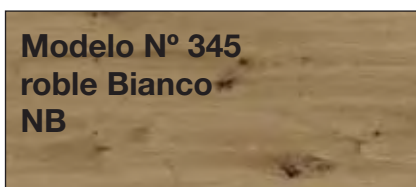

**Modelo N° 345
roble Bianco
NB**

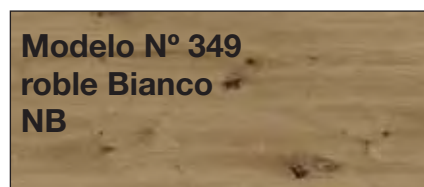

**Modelo N° 349
roble Bianco
NB**

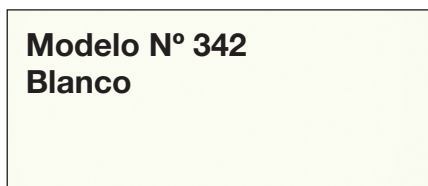

**Modelo N° 342
Blanco**

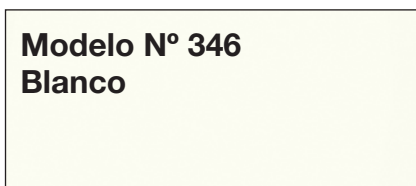

**Modelo N° 346
Blanco**

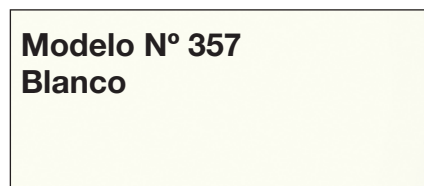

**Modelo N° 357
Blanco**

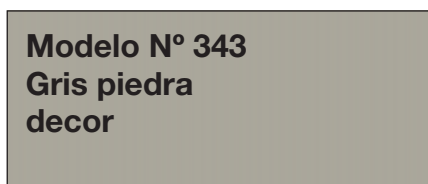

**Modelo N° 343
Gris piedra
decor**

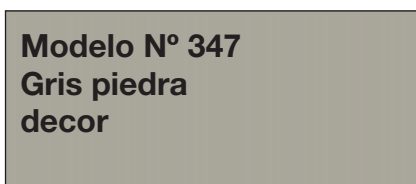

**Modelo N° 347
Gris piedra
decor**

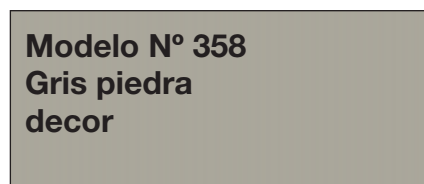

**Modelo N° 358
Gris piedra
decor**

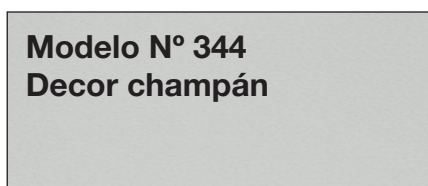

**Modelo N° 344
Decor champán**

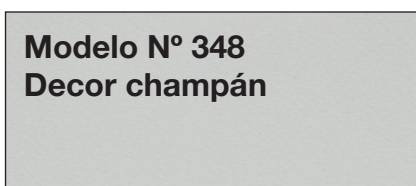

**Modelo N° 348
Decor champán**

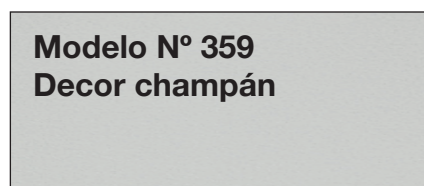

**Modelo N° 359
Decor champán**

furnplan

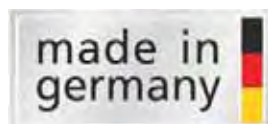

Monaco 3000. Armarios puerta corredera.

V.i.P.
by Wiemann

ejecución de frentes:

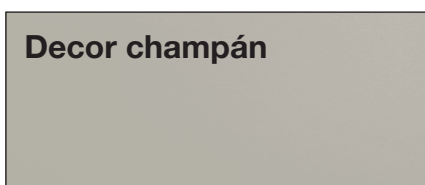
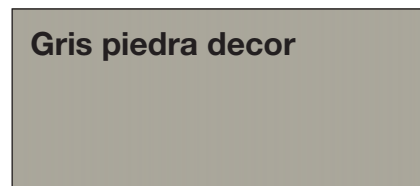
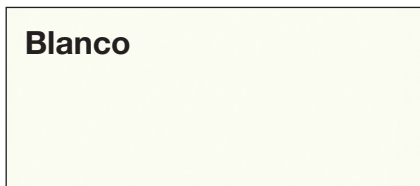
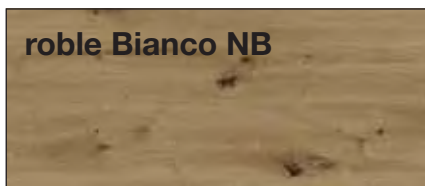

frentes cristal

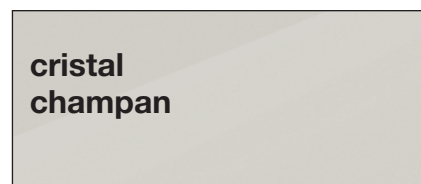
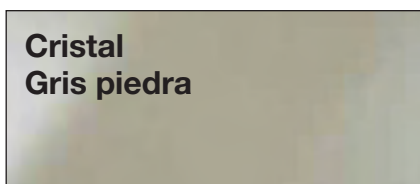
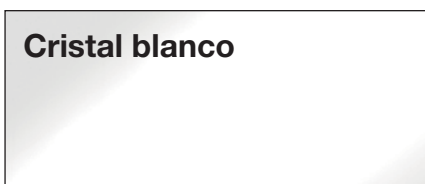

Espejo

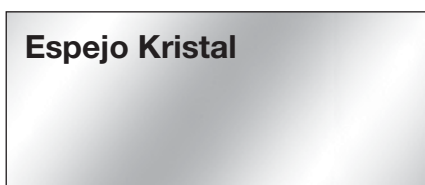

color interior

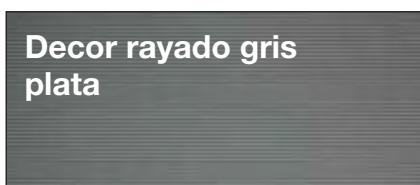

furnplan

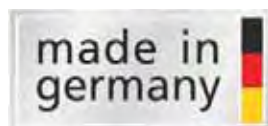

Monaco 3000. Armarios puerta corredera.

V.i.P.
by Wiemann

Anchos de armazón

Armarios de puertas correderas

Ancho	Costado	Zócalo	Costado	Zócalo	Costado	Zócalo	Costado	Zócalo	Costado	Ancho efectivo
150	1,5	72,2	1,5	72,2	1,5					148,9 cm
200	1,5	96,4	1,5	96,4	1,5					197,3 cm
225	1,5	72,2	1,5	72,2	1,5	72,2	1,5			222,6 cm
250	1,5	80,1	1,5	80,1	1,5	80,1	1,5			246,3 cm
280	1,5	96,4	1,5	80,1	1,5	96,4	1,5			278,9 cm
300	1,5	96,4	1,5	96,4	1,5	96,4	1,5			295,2 cm
300	1,5	72,2	1,5	72,2	1,5	72,2	1,5	72,2	1,5	296,3 cm
330	1,5	80,1	1,5	80,1	1,5	80,1	1,5	80,1	1,5	327,9 cm
400	1,5	96,4	1,5	96,4	1,5	96,4	1,5	96,4	1,5	393,1 cm

furnplan

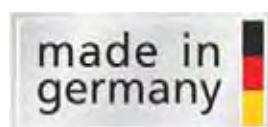

Monaco 3000.

V.i.P.

by Wiemann

Armarios de puertas correderas

Equipamiento interior:
2 baldas, 1 barra para ropa

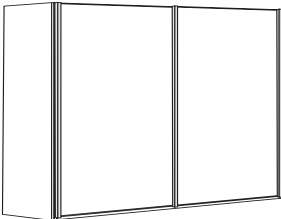
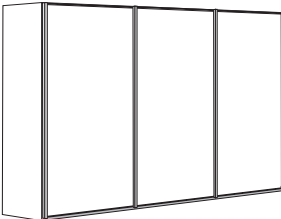
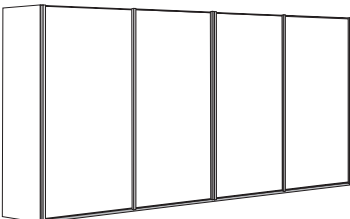
Descripción	Medidas cm		Höhe 217 cm		Altura 236 cm	
	Ancho	Prof.	Ref. N°	EUROS	Ref. N°	EUROS
Frente en color del cuerpo						
	2 Puertas	150	67	200		209
	2 Puertas	200	67	201		210
	3 Puertas	225	67	202		211
	3 Puertas	250	67	203		212
	3 Puertas	280	67	204		213
	3 Puertas	300	67	205		214
	-con apertura incronial					
	4 Puertas	300	67	206		215
	4 Puertas	330	67	207		216
	4 Puertas	400	67	208		217

Distribución de zócalos

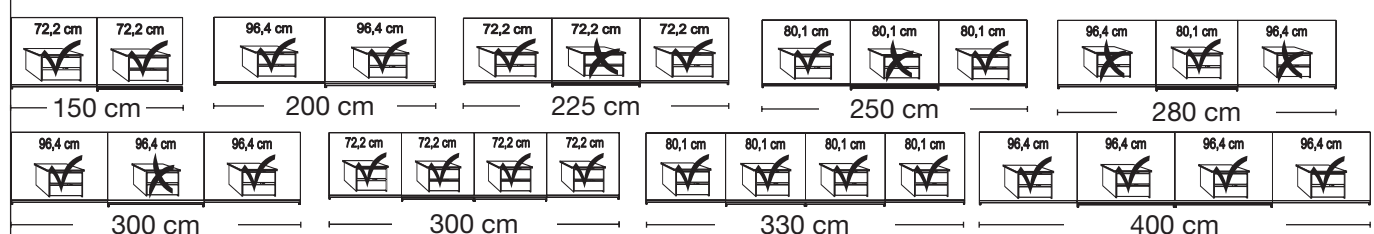



Monaco 3000.

V.i.P.

by Wiemann

Armarios de puertas correderas

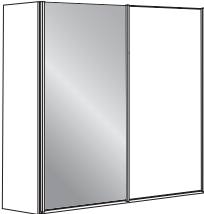
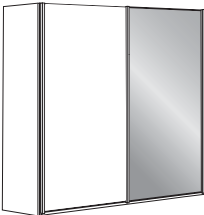
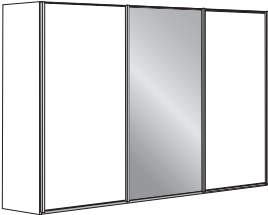
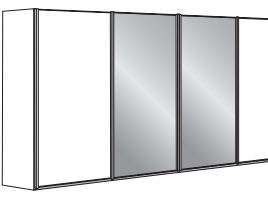
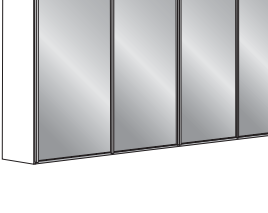
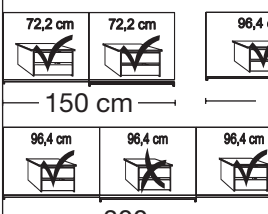
Equipamiento interior:
2 Baldas, 1 barra para ropa

Descripción	Medidas cm		Altura 217 cm		Altura 236 cm	
	Ancho	Prof.	Ref. N°	EUROS	Ref. N°	EUROS
	2 Puertas	1 Puerta espejo izquierda	150	67	218	238
	2 Puertas	1 Puerta espejo derecha	150	67	219	239
	2 Puertas	2 puertas espejo	150	67	220	240
	2 Puertas	1 Puerta espejo izquierda	200	67	221	241
	2 Puertas	1 Puerta espejo derecha	200	67	222	242
	2 Puertas	2 puertas espejo	200	67	223	243
	3 Puertas	1 Puerta espejo central	225	67	224	244
	3 Puertas	3 Puertas espejo	225	67	225	245
	3 Puertas	1 Puerta espejo central	250	67	226	246
	3 Puertas	3 Puertas espejo	250	67	227	247
	3 Puertas	1 Puerta espejo central	280	67	228	248
	3 Puertas	3 Puertas espejo	280	67	229	249
	3 Puertas	1 Puerta espejo central	300	67	230	250
	3 Puertas	3 Puertas espejo	300	67	231	251
	-con apertura sincronizada					
	4 Puertas	2 Puertas espejo centrales	300	67	232	252
	4 Puertas	4 Puertas espejo	300	67	233	253
	4 Puertas	2 Puertas espejo centrales	330	67	234	254
	4 Puertas	4 Puertas espejo	330	67	235	255
	4 Puertas	2 Puertas espejo centrales	400	67	236	256
	4 Puertas	4 Puertas espejo	400	67	237	257

Distribución de zócalos

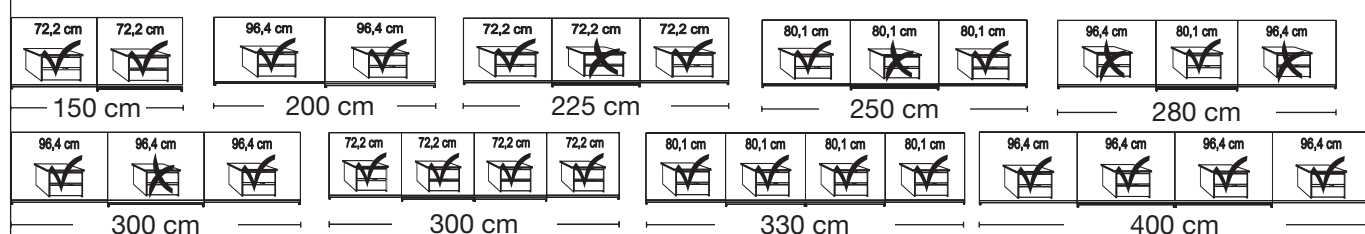

Monaco 3000.

V.i.P.

by Wiemann

Armarios de puertas correderas

Equipamiento interior:
2 Baldas, 1 barra para ropa

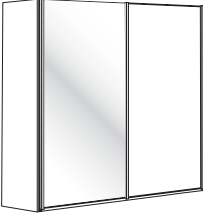
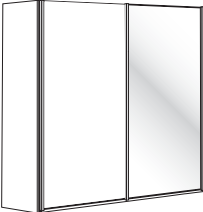
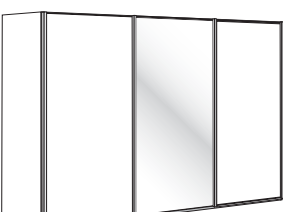
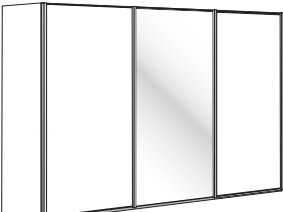
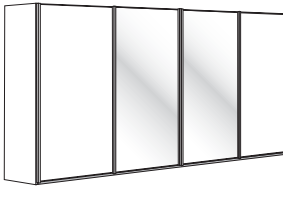
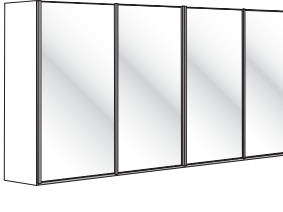
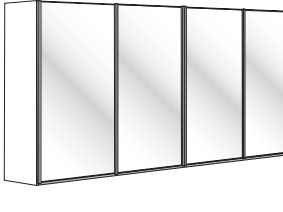
Descripción	Medidas cm		Altura 217 cm		Altura 236 cm	
	Ancho	Prof.	Ref. N°	EUROS	Ref. N°	EUROS
Frentes cristal en blanco combinado con puertas en color armazón						
	2 Puertas	1 Puerta de cristal, izquierda	150	67	258	278
	2 Puertas	1 Puerta de cristal, derecha	150	67	259	279
	2 Puertas	2 Puertas de cristal	150	67	260	280
	2 Puertas	1 Puerta de cristal, izquierda	200	67	261	281
	2 Puertas	1 Puerta de cristal, derecha	200	67	262	282
	2 Puertas	2 Puertas de cristal	200	67	263	283
	3 Puertas	1 Puerta de cristal central	225	67	264	284
	3 Puertas	3 Puertas de cristal	225	67	265	285
	3 Puertas	1 Puerta de cristal central	250	67	266	286
	3 Puertas	3 Puertas de cristal	250	67	267	287
	3 Puertas	1 Puerta de cristal central	280	67	268	288
	3 Puertas	3 Puertas de cristal	280	67	269	289
	3 Puertas	1 Puerta de cristal central	300	67	270	290
	3 Puertas	3 Puertas de cristal	300	67	271	291
	-con apertura sincronizada					
	4 Puertas	2 Puertas de cristal centrales	300	67	272	292
	4 Puertas	4 Puertas de cristal	300	67	273	293
	4 Puertas	2 Puertas de cristal centrales	330	67	274	294
	4 Puertas	4 Puertas de cristal	330	67	275	295
	4 Puertas	2 Puertas de cristal centrales	400	67	276	296
	4 Puertas	4 Puertas de cristal	400	67	277	297

Distribución de zócalos

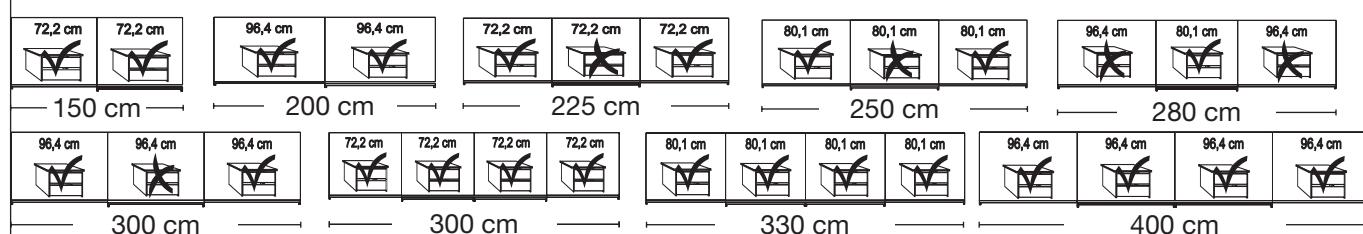

Monaco 3000.

V.i.P.

by Wiemann

Armarios de puertas correderas

Equipamiento interior:
2 Baldas, 1 barra para ropa

Descripción	Medidas cm		Altura 217 cm		Altura 236 cm	
	Ancho	Prof.	Ref. N°	EUROS	Ref. N°	EUROS
Puertas de cristal blanco y puertas de espejo Kristall						
	2 Puertas 1 Puerta espejo izquierda	150	67	298		318
	2 Puertas 1 Puerta espejo derecha	150	67	299		319
	2 Puertas 2 puertas espejo	150	67	300		320
	2 Puertas 1 Puerta espejo izquierda	200	67	301		321
	2 Puertas 1 Puerta espejo derecha	200	67	302		322
	2 Puertas 2 puertas espejo	200	67	303		323
	3 Puertas 1 Puerta espejo central	225	67	304		324
	3 Puertas 3 Puertas espejo	225	67	305		325
	3 Puertas 1 Puerta espejo central	250	67	306		326
	3 Puertas 3 Puertas espejo	250	67	307		327
	3 Puertas 1 Puerta espejo central	280	67	308		328
	3 Puertas 3 Puertas espejo	280	67	309		329
	3 Puertas 1 Puerta espejo central	300	67	310		330
	3 Puertas 3 Puertas espejo	300	67	311		331
	-con apertura sincronizada					
	4 Puertas 2 Puertas espejo centrales	300	67	312		332
	4 Puertas 4 Puertas espejo	300	67	313		333
	4 Puertas 2 Puertas espejo centrales	330	67	314		334
	4 Puertas 4 Puertas espejo	330	67	315		335
	4 Puertas 2 Puertas espejo centrales	400	67	316		336
	4 Puertas 4 Puertas espejo	400	67	317		337

Distribución de zócalos

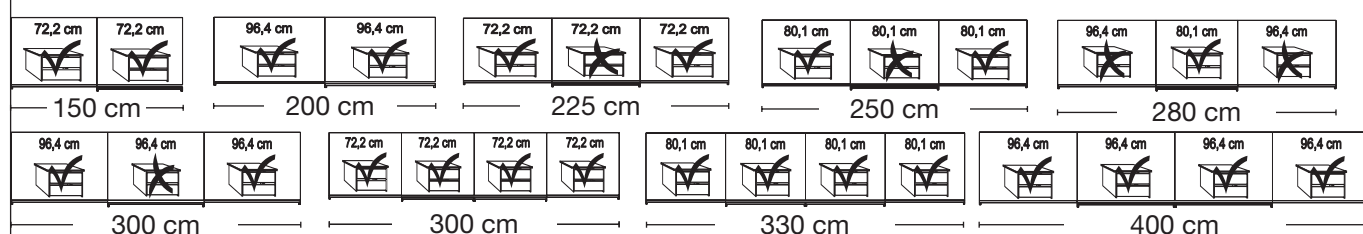

Monaco 3000.

V.i.P.

by Wiemann

Armarios de puertas correderas

Equipamiento interior:
2 Baldas, 1 barra para ropa

Descripción	Medidas cm		Altura 217 cm		Altura 236 cm	
	Ancho	Prof.	Ref. N°	EUROS	Ref. N°	EUROS
Frente cristal en gris piedra combinado con puertas en color armazón						
	2 Puertas	1 Puerta de cristal, izquierda	150	67	338	358
	2 Puertas	1 Puerta de cristal, derecha	150	67	339	359
	2 Puertas	2 Puertas de cristal	150	67	340	360
	2 Puertas	1 Puerta de cristal, izquierda	200	67	341	361
	2 Puertas	1 Puerta de cristal, derecha	200	67	342	362
	2 Puertas	2 Puertas de cristal	200	67	343	563
	3 Puertas	1 Puerta de cristal central	225	67	344	564
	3 Puertas	3 Puertas de cristal	225	67	345	565
	3 Puertas	1 Puerta de cristal central	250	67	346	366
	3 Puertas	3 Puertas de cristal	250	67	347	367
	3 Puertas	1 Puerta de cristal central	280	67	348	368
	3 Puertas	3 Puertas de cristal	280	67	349	569
	3 Puertas	1 Puerta de cristal central	300	67	350	570
	3 Puertas	3 Puertas de cristal	300	67	351	371
	-con apertura sincronizada					
	4 Puertas	2 Puertas de cristal centrales	300	67	352	372
	4 Puertas	4 Puertas de cristal	300	67	353	373
	4 Puertas	2 Puertas de cristal centrales	330	67	354	374
	4 Puertas	4 Puertas de cristal	330	67	355	375
	4 Puertas	2 Puertas de cristal centrales	400	67	356	376
	4 Puertas	4 Puertas de cristal	400	67	357	377

Distribución de zócalos

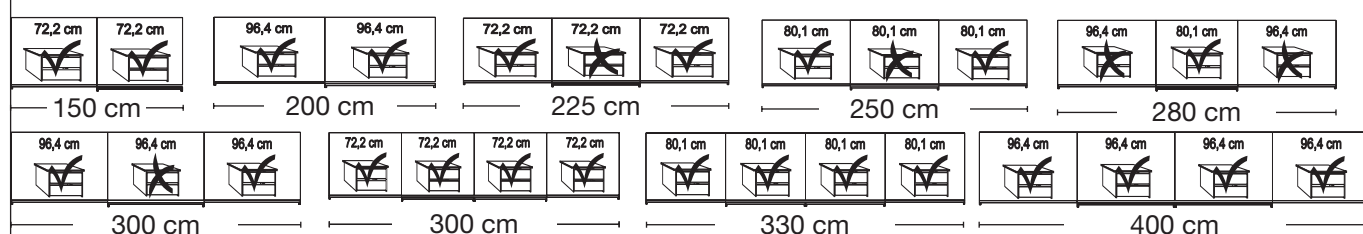





Monaco 3000.

V.i.P.

by Wiemann

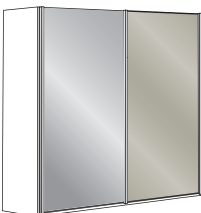
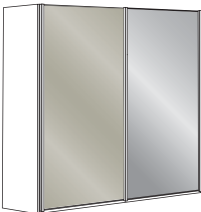
Armarios de puertas correderas

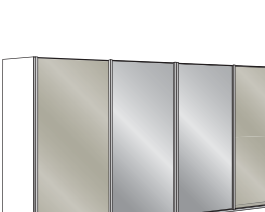
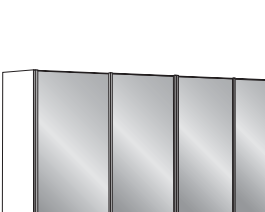
Equipamiento interior:
2 Baldas, 1 barra para ropa

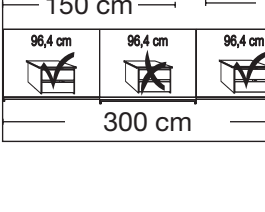
Descripción	Medidas cm		Altura 217 cm		Altura 236 cm	
	Ancho	Prof.	Ref. N°	EUROS	Ref. N°	EUROS
Puertas cristal en gris piedra y puertas de espejo Kristall						
 2 Puertas 1 Puerta espejo izquierda	150	67	378		398	
2 Puertas 1 Puerta espejo derecha	150	67	379		399	
2 Puertas 2 puertas espejo	150	67	380		400	
 2 Puertas 1 Puerta espejo izquierda	200	67	381		401	
2 Puertas 1 Puerta espejo derecha	200	67	382		402	
2 Puertas 2 puertas espejo	200	67	383		403	
 3 Puertas 1 Puerta espejo central	225	67	384		404	
3 Puertas 3 Puertas espejo	225	67	385		405	
 3 Puertas 1 Puerta espejo central	250	67	386		406	
3 Puertas 3 Puertas espejo	250	67	387		407	
 3 Puertas 1 Puerta espejo central	280	67	388		408	
3 Puertas 3 Puertas espejo	280	67	389		409	
 3 Puertas 1 Puerta espejo central	300	67	390		410	
3 Puertas 3 Puertas espejo	300	67	391		411	
-con apertura sincronizada						
 4 Puertas 2 Puertas espejo centrales	300	67	392		412	
4 Puertas 4 Puertas espejo	300	67	393		413	
4 Puertas 2 Puertas espejo centrales	330	67	394		414	
4 Puertas 4 Puertas espejo	330	67	395		415	
4 Puertas 2 Puertas espejo centrales	400	67	396		416	
4 Puertas 4 Puertas espejo	400	67	397		417	

Distribución de zócalos

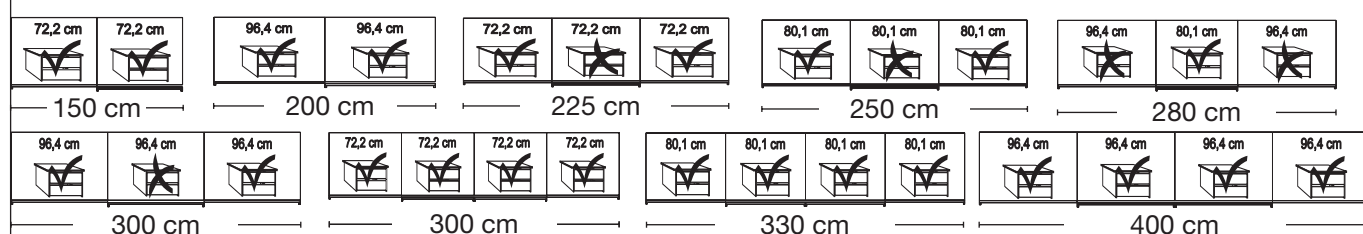

Monaco 3000.

V.i.P.

by Wiemann

Armarios de puertas correderas

Equipamiento interior:
2 Baldas, 1 barra para ropa

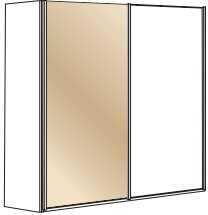
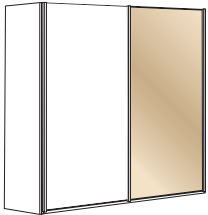
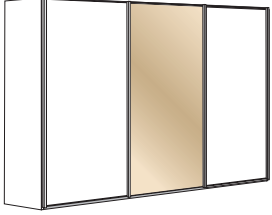
Descripción	Medidas cm		Altura 217 cm		Altura 236 cm		
	Ancho	Prof.	Ref. N°	EUROS	Ref. N°	EUROS	
	2 Puertas	1 Puerta de cristal, izquierda	150	67	418	438	
	2 Puertas	1 Puerta de cristal, derecha	150	67	419	439	
	2 Puertas	2 Puertas de cristal	150	67	420	440	
	2 Puertas	1 Puerta de cristal, izquierda	200	67	421	441	
	2 Puertas	1 Puerta de cristal, derecha	200	67	422	442	
	2 Puertas	2 Puertas de cristal	200	67	423	443	
	3 Puertas	1 Puerta de cristal central	225	67	424	444	
	3 Puertas	3 Puertas de cristal	225	67	425	445	
	3 Puertas	1 Puerta de cristal central	250	67	426	446	
	3 Puertas	3 Puertas de cristal	250	67	427	447	
	3 Puertas	1 Puerta de cristal central	280	67	428	448	
	3 Puertas	3 Puertas de cristal	280	67	429	449	
	3 Puertas	1 Puerta de cristal central	300	67	430	450	
	3 Puertas	3 Puertas de cristal	300	67	431	451	
		-con apertura sincronizada					
		4 Puertas	2 Puertas de cristal centrales	300	67	432	452
		4 Puertas	4 Puertas de cristal	300	67	433	453
		4 Puertas	2 Puertas de cristal centrales	330	67	434	454
		4 Puertas	4 Puertas de cristal	330	67	435	455
		4 Puertas	2 Puertas de cristal centrales	400	67	436	456
4 Puertas		4 Puertas de cristal	400	67	437	457	

Distribución de zócalos

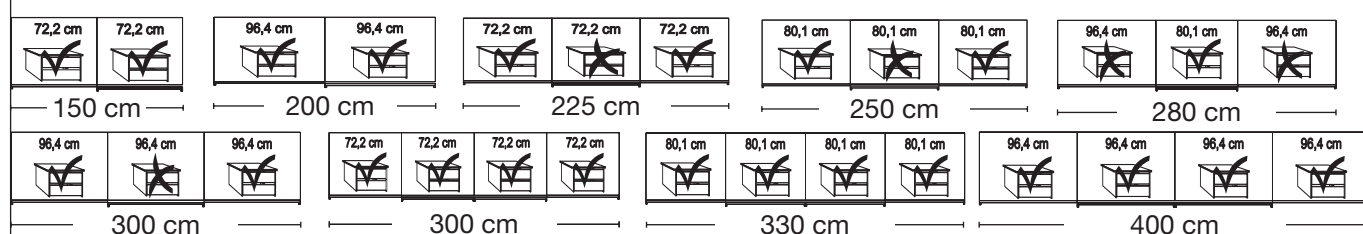





Monaco 3000.

V.i.P.

by Wiemann

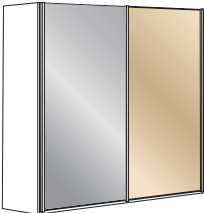
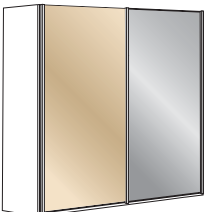
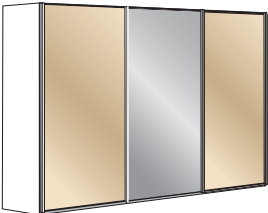
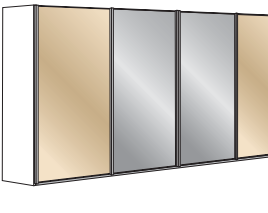
Armarios de puertas correderas

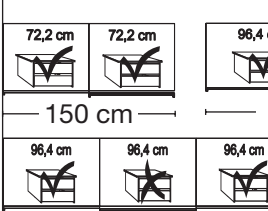
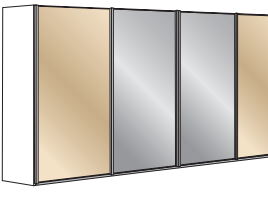
Equipamiento interior:
2 Baldas, 1 barra para ropa

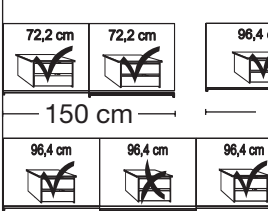
Descripción	Medidas cm		Altura 217 cm		Altura 236 cm	
	Ancho	Prof.	Ref. N°	EUROS	Ref. N°	EUROS
Puertas de cristal en champán y puertas de espejo Kristall						
 2 Puertas 1 Puerta espejo izquierda	150	67	458		478	
2 Puertas 1 Puerta espejo derecha	150	67	459		479	
2 Puertas 2 puertas espejo	150	67	460		480	
 2 Puertas 1 Puerta espejo izquierda	200	67	461		481	
2 Puertas 1 Puerta espejo derecha	200	67	462		482	
2 Puertas 2 puertas espejo	200	67	463		483	
 3 Puertas 1 Puerta espejo central	225	67	464		484	
3 Puertas 3 Puertas espejo	225	67	465		485	
 3 Puertas 1 Puerta espejo central	250	67	466		486	
3 Puertas 3 Puertas espejo	250	67	467		487	
 3 Puertas 1 Puerta espejo central	280	67	468		488	
3 Puertas 3 Puertas espejo	280	67	469		489	
 3 Puertas 1 Puerta espejo central	300	67	470		490	
3 Puertas 3 Puertas espejo	300	67	471		491	
-con apertura sincronizada						
 4 Puertas 2 Puertas espejo centrales	300	67	472		492	
4 Puertas 4 Puertas espejo	300	67	473		493	
 4 Puertas 2 Puertas espejo centrales	330	67	474		494	
4 Puertas 4 Puertas espejo	330	67	475		495	
 4 Puertas 2 Puertas espejo centrales	400	67	476		496	
4 Puertas 4 Puertas espejo	400	67	477		497	

Distribución de zócalos

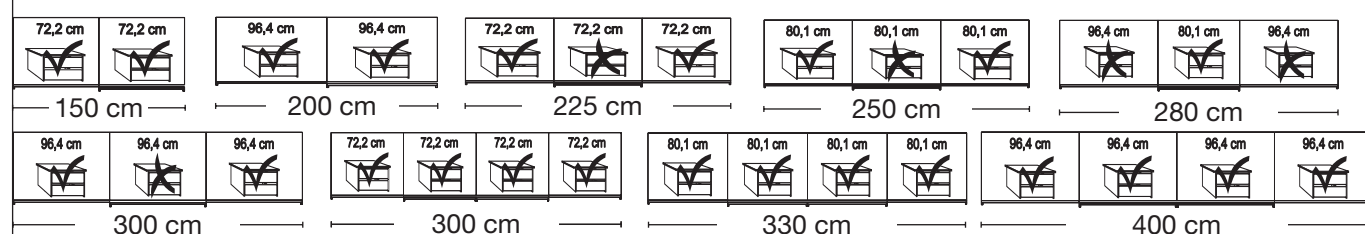

Monaco 3000.

V.i.P.
by Wiemann

Armarios de rincón sin moldura de cornisa

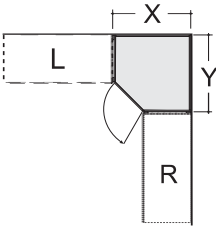
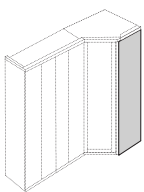

En combinación con Armarios puerta corredera no se pueden utilizar cornisas o marcos passepartout!

Descripción	Medidas cm		Altura 216 cm		Altura 236 cm		
	Ancho	Prof.	Ref. N°	EUROS	Ref. N°	EUROS	
 <p>Armario de rincón</p> <p>Para puerta apertura izqda.:</p> <p>1 Puerta - Frente en color del cuerpo</p> <p>1 Puerta - Frente en cristal blanco</p> <p>1 Puerta - Frente en cristal gris piedra</p> <p>1 Puerta - Frente en cristal champán</p> <p>1 Puerta - Frente en cristal espejo</p> <hr/> <p>Puerta apertura dcha.:</p> <p>1 Puerta - Frente en color del cuerpo</p> <p>1 Puerta - Frente en cristal blanco</p> <p>1 Puerta - Frente en cristal gris piedra</p> <p>1 Puerta - Frente en cristal champán</p> <p>1 Puerta - Frente en cristal espejo</p>  <p>Dimensiones ver página 19 / 20</p> <p>Equipamiento interior: 2 Baldas, 1 barra para ropa</p>							
		93	93	774		779	
		93	93	775		780	
		93	93	776		781	
		93	93	777		782	
		93	93	778		783	
		93	93	784		789	
		93	93	785		790	
		93	93	786		791	
		93	93	787		792	
		93	93	788		793	
 <p>Costado de terminación para Armario rincón, aplicable a izda. y dcha.</p> <p>Se precisa, cuando se remata con un armario de rincón ampliado. Si se coloca un armario de rincón separado, se necesitarán 2 paneles laterales</p>	56	1,5	090		091		



Monaco 3000.

V.i.P.
by Wiemann

Armarios de rincón sin moldura de cornisa

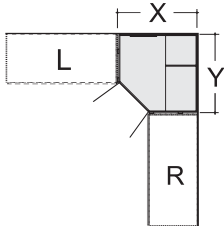

En combinación con Armarios puerta corredera no se pueden utilizar cornisas o marcos passepartout!

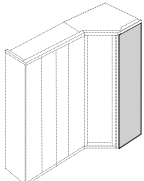
Descripción	Medidas cm		Altura 216 cm		Altura 236 cm	
	Ancho	Prof.	Ref. N°	EUROS	Ref. N°	EUROS
 <p>Vestidor esquina con puertas batientes</p> <p>2 Puertas - Frente en color del cuerpo</p> <p>2 Puertas - Frente en cristal blanco</p> <p>2 Puertas - Frente en cristal gris piedra</p> <p>2 Puertas - Frente en cristal champán</p> <p>2 Puertas - Frente en cristal espejo</p>						
 <p>Dimensiones ver página 19 / 20</p>						
<p>Equipamiento interior: An 72,2 cm: 2 baldas, 1 barra, Ancho 125 cm: 5 baldas, Iluminación con sensor de movimiento</p> <p>vattios por lampara: 2,7 Lumen: 65 Durabilidad h: 30000 Tipo de iluminación: LED Eficiencia energética: A+</p> <p>Esta lampara contiene lamparas LED encastradas. Las lamparas no se pueden sustituir.</p> 						
 <p>Costado de terminación para Armario rincón pasable tipo vestidor, aplicable a izda. y dcha.</p> <p>es necesario en combinación con un armarios vestidor o de esquina como terminal. en caso de montar un armario esquina suelto son necesarios 2 costados exteriores.</p>	56	1,5	090		091	



Monaco 3000.

V.i.P.
by Wiemann

Armarios de rincón sin moldura de cornisa

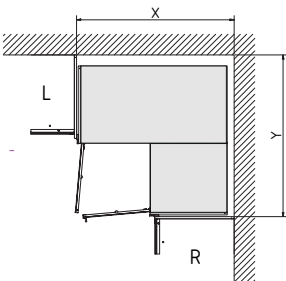

En combinación con Armarios puerta corredera no se pueden utilizar cornisas o marcos passepartout!

Descripción	Medidas cm		Altura 216 cm		Altura 236 cm	
	Ancho	Prof.	Ref. N°	EUROS	Ref. N°	EUROS
 <p>Armario esquina 90 grados con puertas batientes</p> <ul style="list-style-type: none"> - Frente en color del cuerpo - Frente en cristal blanco - Frente en cristal gris piedra - Frente en cristal champán - Frente en cristal espejo   <p>Equipamiento interior: 2 baldas 105 cm x 105 cm, 2 barras 71,5 cm</p> <p>Dimensiones ver página 19 / 20</p>	108	108	968		992	
	108	108	969		993	
	108	108	989		994	
	108	108	990		995	
	108	108	991		996	



Monaco 3000.

V.i.P.
by Wiemann

Armarios de rincón sin moldura de cornisa

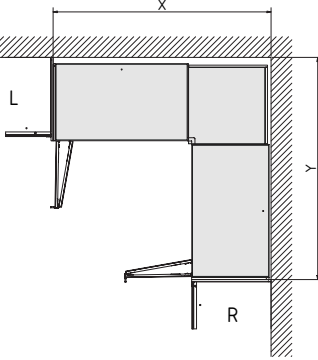

En combinación con Armarios puerta corredera no se pueden utilizar cornisas o marcos passepartout!

Descripción	Medidas cm		Altura 216 cm		Altura 236 cm	
	Ancho	Prof.	Ref. N°	EUROS	Ref. N°	EUROS
 <p>Armario esquina 90 grados con puertas plegables</p> <ul style="list-style-type: none"> - Frente en color del cuerpo - Frente en cristal blanco - Frente en cristal gris piedra - Frente en cristal champán - Frente en cristal espejo   <p>Equipamiento interior: An 55,8 cm: 2 baldas An 96,4 cm: 4 baldas 2 barras 152 cm</p>	157	157	814		819	
	157	157	815		820	
	157	157	816		821	
	157	157	817		822	
	157	157	818		823	

Medidas Armario de rincón

debido a diferentes dimensiones de profundidad
superficie requerida:

Armario modulo Izq	Armario modulo DER	Superficie requerida para arm. esquina
Armario puerta batiente/plegable, Estantería	Armario PC, 2 - 4 puertas	X = 98,0 cm Y = 94,2 cm
Armario PC, 2-puertas	Armario puerta batiente/plegable, Estantería	X = 94,2 cm Y = 101,0 cm
Armario PC 3 - 4 puertas	Armario puerta batiente/plegable, Estantería	X = 94,2 cm Y = 98,0 cm
Armario PC, 2-puertas	Armario PC, 2 - 4 puertas	X = 99,2 cm Y = 102,2 cm
Armario PC 3 - 4 puertas	Armario PC, 2 - 4 puertas	X = 99,2 cm Y = 99,2 cm

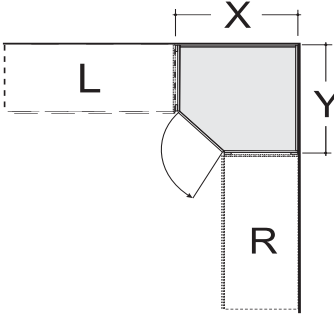



Armario de rincón

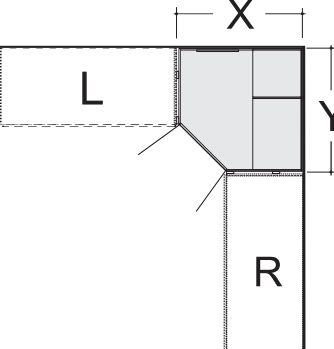

Schrank Schenkel L	Schrank Schenkel R	Superficie requerida para vestidor esquina
Armario puerta batiente/plegable, Estantería	Armario PC, 2 - 4 puertas	X = 134,4 cm Y = 126,9 cm
Armario PC, 2-puertas	Armario puerta batiente/plegable, Estantería	X = 130,6 cm Y = 134,2 cm
SWT-Schrank, 3-4-türig	Armario puerta batiente/plegable, Estantería	X = 130,6 cm Y = 131,2 cm
Armario PC, 2-puertas	Armario PC, 2 - 4 puertas	X = 135,6 cm Y = 135,4 cm
SWT-Schrank, 3-4-türig	Armario PC, 2 - 4 puertas	X = 135,6 cm Y = 132,4 cm



Vestidor esquina con puertas batientes



Medidas Armario de rincón

debido a diferentes dimensiones de profundidad
superficie requerida:

Armario modulo Izq	Armario modulo DER	Espacio requerido para armarios de esquina de más de 90 grados con puertas batientes	
Armario puerta batiente/plegable, Estantería	Armario PC, 2 - 4 puertas	X = 114,2 cm Y = 107,9 cm	
Armario PC, 2-puertas	Armario puerta batiente/plegable, Estantería	X = 107,9 cm Y = 117,2 cm	
Armario PC 3 - 4 puertas	Armario puerta batiente/plegable, Estantería	X = 107,9 cm Y = 114,2 cm	
Armario PC, 2-puertas	Armario PC, 2 - 4 puertas	X = 114,2 cm Y = 117,2 cm	
Armario PC 3 - 4 puertas	Armario PC, 2 - 4 puertas	X = 114,2 cm Y = 114,2 cm	
			Armario Esquina 90 grados con puertas batientes

Armario modulo Izq	Armario modulo DER	Espacio requerido para armarios de esquina de más de 90 grados con puertas plegables	
Armario puerta batiente/plegable, Estantería	Armario PC, 2 - 4 puertas	X = 158,0 cm Y = 156,5 cm	
Armario PC, 2-puertas	Armario puerta batiente/plegable, Estantería	X = 156,5 cm Y = 161,0 cm	
Armario PC 3 - 4 puertas	Armario puerta batiente/plegable, Estantería	X = 156,5 cm Y = 158,0 cm	
Armario PC, 2-puertas	Armario PC, 2 - 4 puertas	X = 158,0 cm Y = 161,0 cm	
Armario PC 3 - 4 puertas	Armario PC, 2 - 4 puertas	X = 158,0 cm Y = 158,0 cm	
			Armario esquina ángulo 90 grados con puertas plegables

Monaco 3000.

V.i.P.
by Wiemann





Estantería sin moldura de cornisa

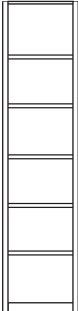

¡No combinado con el marco passepartout y molduras de cornisa!

Descripción	Medidas cm		Altura 216 cm		Altura 236 cm	
	Ancho	Prof.	Ref. N°	EUROS	Ref. N°	EUROS
 <p>Estantería abierto en color amazón, con 5 baldas</p>	40	36	840		841	



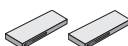



Accesorios para armario

D		M			N	
		A	A	B	B	B
	Amortiguación - para armarios 2 puertas 1 Unidad Función óptima solo en combinación con amortiguación de puerta externa	28	4	2	369	
	 - para armarios 3-4 puertas 2 Unidades Función optima solo en combinación con la amortiguación de las puertas exteriores y central !	28	4	2	370	
 	amortiguación cierre para puertas centrales - Para armarios de 3 puertas* Unidad - Para armarios de 4 puertas Unidad	24	2	11	363	
	 * Por favor, comprobar altura de techo ! Solo se puede realizar el montaje desde la parte superior del armario!	24	2	11	364	
	Set de 2 unid. con amortiguación para puertas exteriores, Set para armarios 2-,3-, y 4 puertas Par	24	2	11	365	

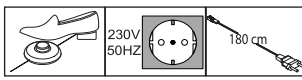

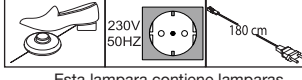

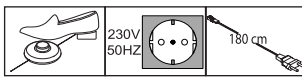
Monaco 3000.

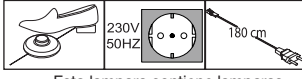
V.i.P.
by Wiemann

Accesorios para armario

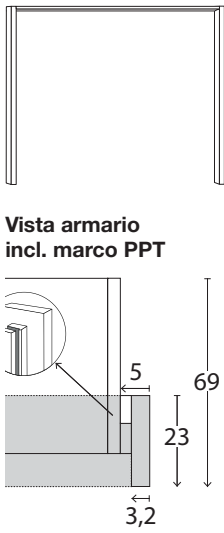
 <p>Lámpara LED-Line plana plateada</p> <p>vattios por lámpara: 5,5 Lumen x lámpara: 330 Tipo de iluminación: LED Eficiencia energética: A+</p>  <p>Esta lámpara contiene lámparas LED encastradas. Las lámparas no se pueden sustituir.</p>  <p>Solo en combinación con marcos passe-partout y cornisas!</p>	M			N	
	A	A	B	B	B
1 Unidad	60	1,5	4,5		980
2 Unidades	60	1,5	4,5		981
3 Unidades	60	1,5	4,5		982
 <p>lámpara LED-Line en plata</p> <p>vattios por lámpara: 5,5 Lumen x lámpara: 330 Tipo de iluminación: LED Eficiencia energética: A+</p>  <p>Esta lámpara contiene lámparas LED encastradas. Las lámparas no se pueden sustituir.</p>					
1 Unidad	60	6	19		983
2 Unidades	60	6	19		984
3 Unidades	60	6	19		985
 <p>Lámpara LED-Line plana en negro</p> <p>vattios por lámpara: 5,5 Lumen x lámpara: 330 Tipo de iluminación: LED Eficiencia energética: A+</p>  <p>Esta lámpara contiene lámparas LED encastradas. Las lámparas no se pueden sustituir.</p>  <p>Solo en combinación con marcos passe-partout y cornisas!</p>					
1 Unidad	60	1,5	4,5		880
2 Unidades	60	1,5	4,5		881
3 Unidades	60	1,5	4,5		882
 <p>lámpara LED-Line en negro</p> <p>vattios por lámpara: 5,5 Lumen x lámpara: 330 Tipo de iluminación: LED Eficiencia energética: A+</p>  <p>Esta lámpara contiene lámparas LED encastradas. Las lámparas no se pueden sustituir.</p>					
1 Unidad	60	6	19		883
2 Unidades	60	6	19		884
3 Unidades	60	6	19		885

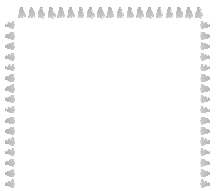
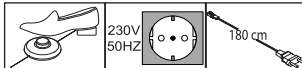
Marco passepartout para armarios de puertas correderas con o sin iluminación

Descripción	Medidas cm		Höhe 221 cm		Höhe 240 cm		
	Ancho	Prof.	Ref. N°	EUROS	Ref. N°	EUROS	
 <p>Marco passepartout, Ancho costado 3,2 cm, sin iluminación</p> <ul style="list-style-type: none"> - Para ancho de armario de 150 cm - Para ancho de armario de 200 cm - Para ancho de armario de 225 cm - Para ancho de armario de 250 cm - Para ancho de armario de 280 cm - Para ancho de armario de 300 cm - Para ancho de armario de 300 cm - Para ancho de armario de 330 cm - Para ancho de armario de 400 cm <p>Medidas cm</p>	160	23	700		709		
		210	23	701		710	
		235	23	702		711	
		260	23	703		712	
		290	23	704		713	
		310	23	705		714	
							
		310	23	706		715	
							
		340	23	707		716	
		410	23	708		717	
	 <p>Recargo para LED perimetral (opcional):</p> <ul style="list-style-type: none"> - Para ancho de armario de 150 cm - Para ancho de armario de 200 cm - Para ancho de armario de 225 cm - Para ancho de armario de 250 cm - Para ancho de armario de 280 cm - Para ancho de armario de 300 cm - Para ancho de armario de 300 cm - Para ancho de armario de 330 cm - Para ancho de armario de 400 cm <p>vatios por lampara: Lumen x lampara: Tipo de iluminación Eficiencia energética:</p>  <p>Esta lampara contiene lamparas LED encastradas. Las lamparas no se pueden sustituir.</p>	160	23	737		746	
			210	23	738		747
		235	23	739		748	
		260	23	740		749	
		290	23	741		750	
		310	23	742		751	
							
		310	23	743		752	
							
		340	23	744		753	
	410	23	745		754		



No se puede instalar a posteriori!



Por favor tener en cuenta lo siguiente:



Utilizando el marco passepartout, el armario se amplía a las medidas identificadas.

marco passepartout para armarios a partir de 330 cm unión central.

Monaco 3000.

V.i.P.
by Wiemann

Marco passepartout para armarios de puertas correderas con o sin iluminación

Descripción	Medidas cm		Höhe 221 cm		Höhe 240 cm	
	Ancho	Prof.	Ref. N°	EUROS	Ref. N°	EUROS
 <p>Marco passepartout, Ancho de cada costado: 3,2cm, con iluminación</p> <p>2 Lámparas - Para ancho de armario de 150 cm 160</p> <p>4 Lámparas - Para ancho de armario de 200 cm 210</p> <p>6 Lámparas - Para ancho de armario de 225 cm 235</p> <p>6 Lámparas - Para ancho de armario de 250 cm 260</p> <p>6 Lámparas - Para ancho de armario de 280 cm 290</p> <p>6 Lámparas - Para ancho de armario de 300 cm 310</p> <p> - solo para armarios 3 puertas</p> <p>8 Lámparas - Para ancho de armario de 300 cm 310</p> <p> - solo para armarios con 4 puertas</p> <p>8 Lámparas - Para ancho de armario de 330 cm 340</p> <p>8 Lámparas - Para ancho de armario de 400 cm 410</p>						

Vista armario incl. marco PPT

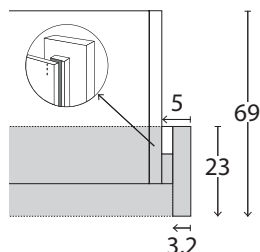

Medidas cm

váticos por lampara: 2,4
Lumen x lampara: 186
Tipo de iluminación: LED
Eficiencia energética: A+

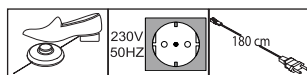

Esta lampara contiene lamparas
LED encastradas. Las lamparas no
se pueden sustituir.



Por favor tener en cuenta lo siguiente:







Utilizando el marco passepartout, el armario se amplía a las medidas identificadas.

marco passepartout para armarios a partir de 330 cm unión central.

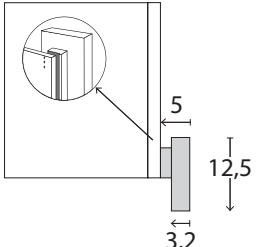

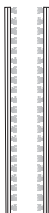

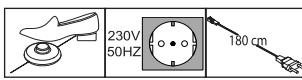

Monaco 3000.

V.i.P.
by Wiemann

Elementos adicionales para armarios de puertas correderas

Descripción	Medidas cm		Höhe 221 cm		Höhe 240 cm	
	Ancho	Prof.	Ref. N°	EUROS	Ref. N°	EUROS
 <p>Costado en color armazón, 2 unid.</p> <p>Vista armario incl. costados</p>  <p>Medidas cm</p> <p> También disponible para Monaco 1000 + 2000!</p>	5	12,5	098		099	
 <p>Iluminación para costados</p> <p> No se puede instalar a posteriori! para costados y marcos passepartout sin iluminación perimetral!</p> <p>vattios por lampara: 0 Lumen x lampara: 0 Tipo de iluminación: EEI LABEL Eficiencia energética: A++</p>  <p> Esta lampara contiene lamparas LED encastradas. Las lamparas no se pueden sustituir.</p>	1,5	1	100		101	

Molduras de cornisa para armarios de puertas correderas con o sin iluminación

Descripción	Medidas cm			Ref. N°	EUROS
	Ancho	Alt.	Prof.		
 Moldura de cornisa, sin iluminación					
- Para ancho de armario de 150 cm	150	5	23	900	
- Para ancho de armario de 200 cm	200	5	23	901	
- Para ancho de armario de 225 cm	225	5	23	902	
- Para ancho de armario de 250 cm	250	5	23	903	
- Para ancho de armario de 280 cm	280	5	23	904	
- Para ancho de armario de 300 cm	300	5	23	905	
 - solo para armarios 3 puertas					
- Para ancho de armario de 300 cm	300	5	23	906	
 - solo para armarios con 4 puertas					
- Para ancho de armario de 330 cm	330	5	23	907	
- Para ancho de armario de 330 cm	400	5	23	908	
 Moldura de cornisa, con iluminación					
2 Lámparas - Para ancho de armario de 150 cm	150	5	23	909	
4 Lámparas - Para ancho de armario de 200 cm	200	5	23	910	
6 Lámparas - Para ancho de armario de 225 cm	225	5	23	911	
6 Lámparas - Para ancho de armario de 250 cm	250	5	23	912	
6 Lámparas - Para ancho de armario de 280 cm	280	5	23	913	
6 Lámparas - Para ancho de armario de 300 cm	300	5	23	914	
 - solo para armarios 3 puertas					
8 Lámparas - Para ancho de armario de 300 cm	300	5	23	915	
 - solo para armarios con 4 puertas					
8 Lámparas - Para ancho de armario de 330 cm	330	5	23	916	
8 Lámparas - Para ancho de armario de 400 cm	400	5	23	917	

vattios por lampara: 2,4
Lumen: 186
Durabilidad h: 30000
Tipo de iluminación: LED
Eficiencia energética: A+





Esta lampara contiene lamparas LED encastradas. Las lamparas no se pueden sustituir.



Cornisa para armarios a partir de 330 cm unión central.



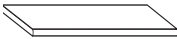
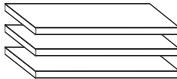
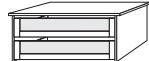
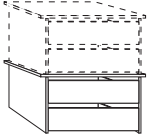
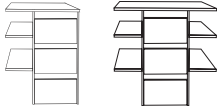
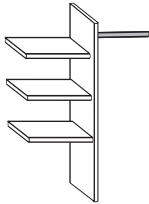

Accesorios para armario

Acabado interior: Rayado en gris plata

	Descripción	Medidas cm			Ref. N°	EUROS
		Ancho	Alt.	Prof.		
	1 balda - para ancho interior 72,2 cm 1 Unidad - Para ancho de 80,1 cm 1 Unidad - Para ancho de 96,4 cm 1 Unidad	72,2	2,2	51,5	036	
		80,1	2,2	51,5	032	
		96,4	2,2	51,5	030	
	3 baldas - para ancho interior 72,2 cm 3 Unidades - Para ancho de 80,1 cm 3 Unidades - Para ancho de 96,4 cm 3 Unidades	72,2	2,2	51,5	038	
		80,1	2,2	51,5	033	
		96,4	2,2	51,5	031	
	unid. int. cajones con 2 cajones con extracción de bolas y frente de cristal para armarios de puerta batiente y armarios puerta corredera - para ancho interior 72,2 cm - Para ancho de 80,1 cm - Para ancho de 96,4 cm	72,2	41	52	068	
		80,1	41	52	069	
		96,4	41	52	070	
	unid. int. cajones con 2 cajones con amortiguación y frente de madera para armarios de puerta batiente y armarios puerta corredera, apilables y montaje a cualquier altura - para ancho interior 72,2 cm - Para ancho de 80,1 cm - Para ancho de 96,4 cm	72,2	41	51,5	071	
		80,1	41	51,5	072	
		96,4	41	51,5	073	
 Ref. N° Ref. N° 023 064	unidad integrable de cajones con 3 cajones con amortiguación y frente de madera - para ancho interior 72,2 cm - Para ancho de 80,1 cm - Para ancho de 96,4 cm	72,2	89	51,5	023	
		80,1	89	51,5	024	
		96,4	89	51,5	064	
	baldas, compuesto de 3 baldas, 1 barra, 1 costado intermedio - para ancho interior 72,2 cm - Para ancho de 80,1 cm - Para ancho de 96,4 cm	72,2	137	51,5	025	
		80,1	137	51,5	026	
		96,4	137	51,5	066	
	¡De utilización bilateral (izquierda o derecha)! Motaje solo sobre base!					

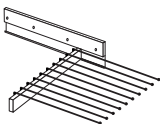
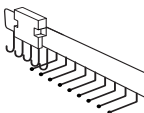
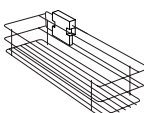

Monaco 3000.

Accesorios para armario Acabado interior: Rayado en gris plata

Descripción	Medidas cm			Ref. Nº	EUROS	
	Ancho	Alt.	Prof.			
 <p>iluminación interior LED para baldas</p> <ul style="list-style-type: none"> - para ancho interior 72,2 cm 1 Unidad 72,2 3 1 002 - Para ancho de 80,1 cm 1 Unidad 80,1 3 1 016 - Para ancho de 96,4 cm 1 Unidad 96,4 3 1 011 - para ancho interior 72,2 cm 2 Unidades 72,2 3 1 003 - Para ancho de 80,1 cm 2 Unidades 80,1 3 1 017 - Para ancho de 96,4 cm 2 Unidades 96,4 3 1 013 - para ancho interior 72,2 cm 3 Unidades 72,2 3 1 004 - Para ancho de 80,1 cm 3 Unidades 80,1 3 1 018 - Para ancho de 96,4 cm 3 Unidades 96,4 3 1 015 <p>vattios por lampara: 6,7 Lumen: 325 Durabilidad h: 30000 Tipo de iluminación: LED Eficiencia energética: A+</p> <p> Esta lampara contiene lamparas LED encastradas. Las lamparas no se pueden sustituir.</p>						
	 <p>Barra para ropa</p> <ul style="list-style-type: none"> - para ancho interior 72,2 cm 72,2 3 2 052 - Para ancho de 80,1 cm 80,1 3 2 051 - Para ancho de 96,4 cm 96,4 3 2 050 					
		 <p>Pantalonero extraible</p> <p>45 10 50 056</p>				
		 <p>Extraible para corbatas y cinturones</p> <p>7 19 45 059</p>				
	 <p>Cajón utensilios extraible</p> <p>16 9 45 076</p>					
	 <p>Soporte para corbatas y cinturones</p> <p>30 27 9 042</p>					

Accesorios para armario

Acabado interior: Rayado en gris plata

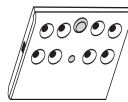
Descripción	Medidas cm			Ref. N°	EUROS
	Ancho	Alt.	Prof.		
 <p>Espejo interior, plegable</p> <p> Solo en combinación armarios puerta corredera!</p>	36	173	2	080	
 <p>LED-Iluminación interior del armario con detector de movimientos, incl. baterías recargables con USB</p> <p>1 Unidad</p> <p>2 Unidades</p> <p>3 Unidades</p> <p>4 Unidades</p>	10	2	10	006	
	10	2	10	007	
	10	2	10	008	
	10	2	10	009	

Monaco 3000. Amarios puerta corredera.

V.i.P.
by Wiemann



Tested for Harmful
emission
Emission Tested
probado

